



RolloTube Comfort

Accessories

Drive bearings

RolloTube Comfort Medium Ø 45 mm

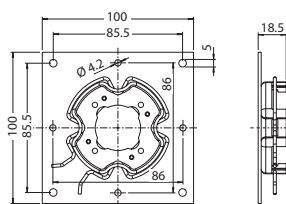

4015K-01

Click drive bearing for VEKA and EXTE roller shutter top boxes

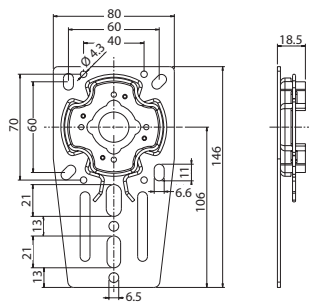

4015K-04

Click-ready box support, angled, height-adjustable

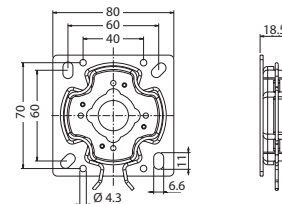

4015K-05

Click universal drive bearing for mounting on masonry or front box / top box units

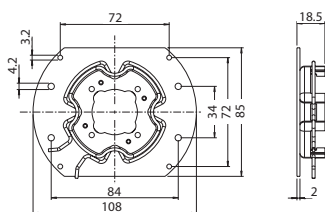

4015K-06

Click drive bearing for Kömmerling, Rehau and Thyssen roller shutter top boxes

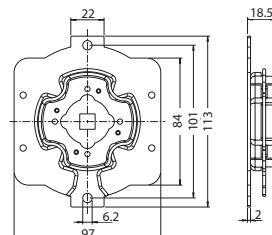

4015K-07

Click drive bearing for Stakusit roller shutter top boxes

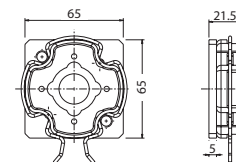

4015K-09

Click drive bearing for awnings with M6 screw thread on a 48 mm semicircle or M8 on a 60 mm semicircle

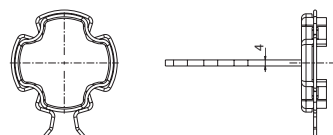

4015K-10

Click drive bearing for plastering into masonry

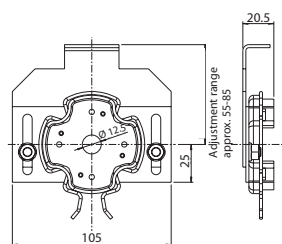

4015K-11

Click clamp bearing for blind capsule systems

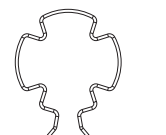

EFE 223-4

Retaining spring, spare part for Click drive bearing

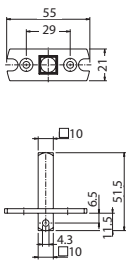

4010-M
Adapter ring, 10 mm square,
including screws

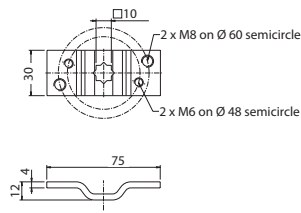

4010-01
Awning drive bearing with M6 screw thread on
48 mm semicircle or M8 on 60 mm semicircle

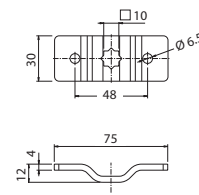

4010-02
Drive bearing, 10 mm star, offset,
two-hole 48 mm semicircle

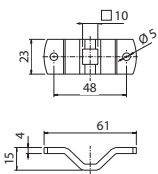

4010-03
Drive bearing, offset, two hole
48 mm semicircle

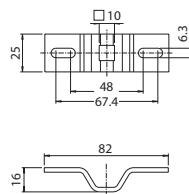

4010-04
Awning drive bearing for awnings with 48
mm semicircle

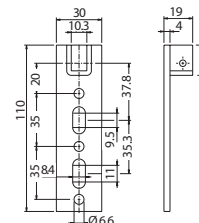

4010-05
Drive bearing for prefabricated boxes,
height adjustable

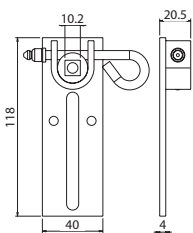

4010-06
Roll-off prefabricated box support, height
adjustable, can be disengaged

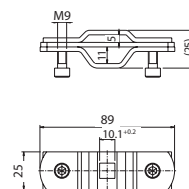

4010-07
Universal clamp bearing for mounting on a
counter bearing provided by the client

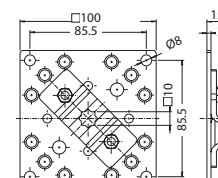

4010-08
Drive bearing on base plate including
screws and nuts