



RolloTube Comfort Radio

Accessories

Adapter ring / drive adapter sets

RolloTube Comfort Radio Small Ø 35 mm

Adapter rings

Drive adapters

Shafts

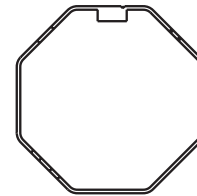
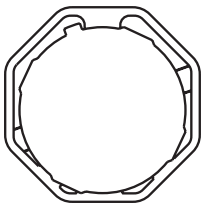

AMC35-SW40 Adapter ring / drive adapter set in polybag

AMC35M-SW40 Adapter ring / drive adapter set pre-mounted on the RolloTube

fits 40 mm AF octagonal steel shaft

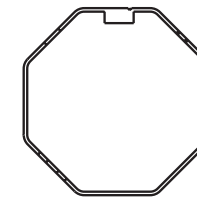
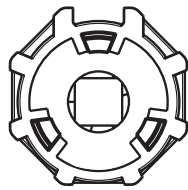
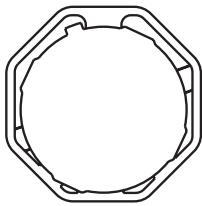

AMC35-SW40H Adapter ring / drive adapter set in polybag for RTCS with obstacle detection

AMC35M-SW40H Adapter ring / drive adapter set on the RTCS with pre-mounted obstacle detection

fits 40 mm AF octagonal steel shaft

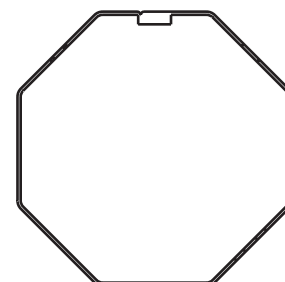
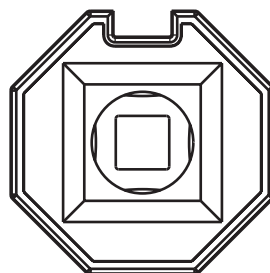
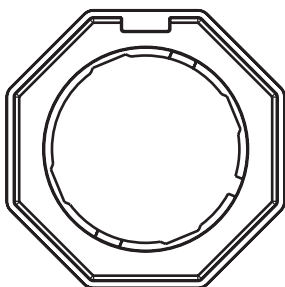

AM35-SW50 Adapter ring / drive adapter set in polybag

AMC35M-SW60 Adapter ring / drive adapter set pre-mounted on the RolloTube

fits 50 mm AF octagonal steel shaft



Adapter rings

Drive adapters

Shafts

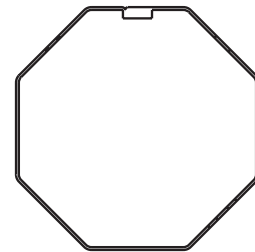
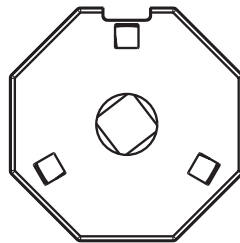
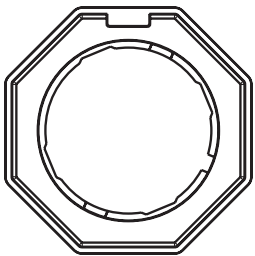

AMC35-SW50H Adapter ring / drive adapter set in polybag for RTCS with obstacle detection fits 50 mm AF octagonal steel shaft
AMC35M-SW50H Adapter ring / drive adapter set on the RTCS with pre-mounted obstacle detection

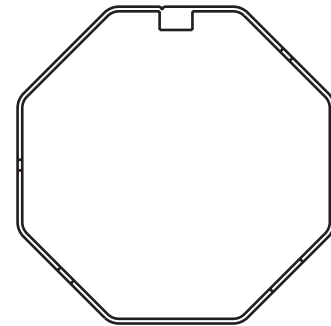
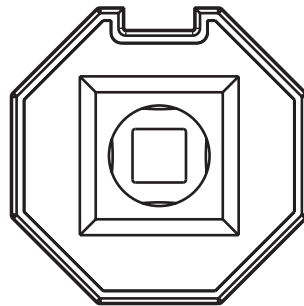
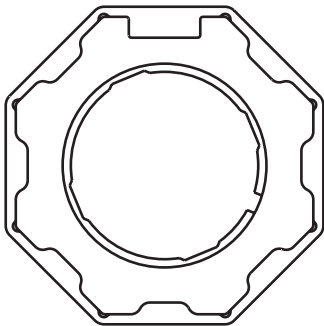

AMC35-SW60 Adapter ring / drive adapter in a polybag fits 60 mm AF octagonal steel shaft
AMC35M-SW60 Adapter ring / drive adapter set pre-mounted on the RolloTube

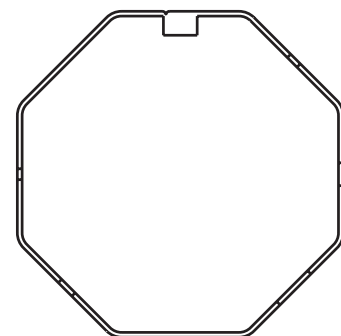
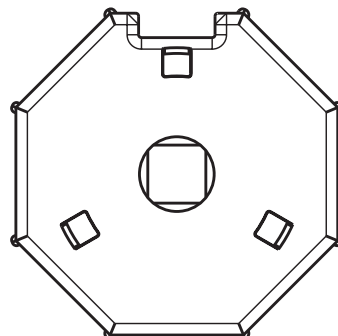
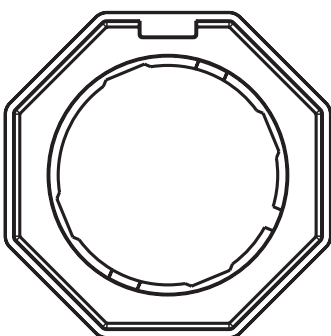

AMC35-SW60H Adapter ring / drive adapter set in polybag for RTCS with obstacle detection fits 60 mm AF octagonal steel shaft
AMC35M-SW40H Adapter ring / drive adapter set on the RTCS with pre-mounted obstacle detection