



RolloTube Comfort

Accessories

Drive bearings

RolloTube Comfort Small Ø 35 mm

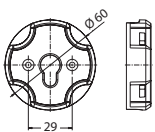

4015K-S

Adapter ring for Click drive bearing

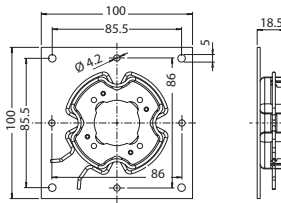

4015K-01

Click drive bearing for VEKA and EXTE roller shutter top boxes

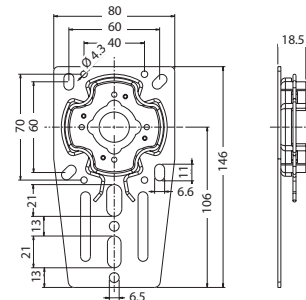

4015K-04

Click-ready box support, angled, height-adjustable

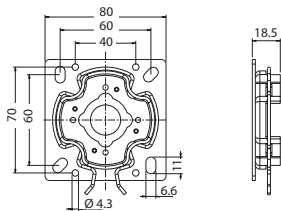

4015K-05

Click universal drive bearing for mounting on masonry or front box / top box units

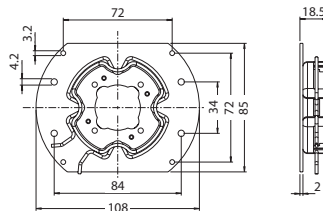

4015K-06

Click drive bearing for Kömmerling, Rehau and Thyssen roller shutter top boxes

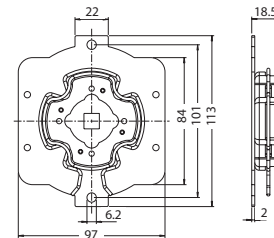

4015K-07

Click drive bearing for Stakusit roller shutter top boxes

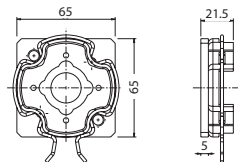

4015K-09

Click drive bearing for awnings with M6 screw thread on a 48 mm semicircle or M8 on a 60 mm semicircle

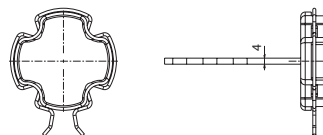

4015K-10

Click drive bearing for plastering into masonry

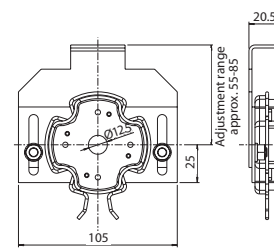

4015K-11

Click clamp bearing for blind capsule systems

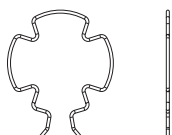

EFE 223-4

Retaining spring, spare part for Click drive bearing

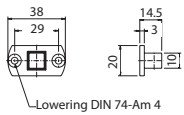

4010-S

Adapter ring, 10 mm square for screwing on against the head of the tubular motor

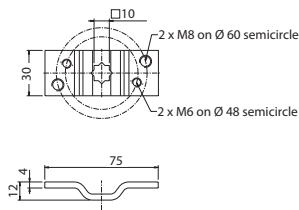

4010-01

Awning drive bearing with M6 screw thread on 48 mm semicircle or M8 on 60 mm semicircle

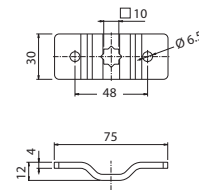

4010-02

Drive bearing, 10 mm star, offset, two-hole 48 mm semicircle

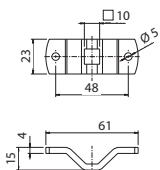

4010-03

Drive bearing, offset, two hole 48 mm semicircle

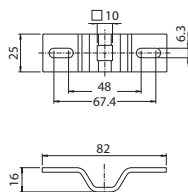

4010-04

Awning drive bearing for awnings with 48 mm semicircle

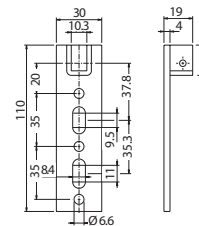

4010-05

Drive bearing for prefabricated boxes, height adjustable

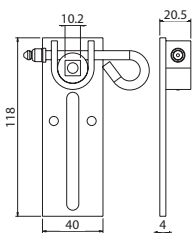

4010-06

Roll-off prefabricated box support, height adjustable, can be disengaged

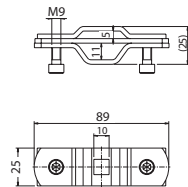

4010-07

Universal clamp bearing for mounting on a counter bearing provided by the client

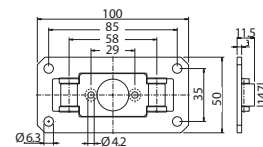

3313

Universal drive bearing for front box / top box units and where space is restricted